

Absolute encoders – multiturn

**Compact, robust
electronic multiturn, magnetic**

Sendix M3661R (shaft)

Analog



The Sendix M36 with Energy Harvesting Technology is an electronic multiturn encoder in miniature format, without gear and without battery.

The "R" obust version is particularly suitable for use in harsh environments. Protected up to IP69k, resistance against shock and extreme temperature fluctuations, the Sendix M36 encoder is suitable even for demanding outdoor applications.

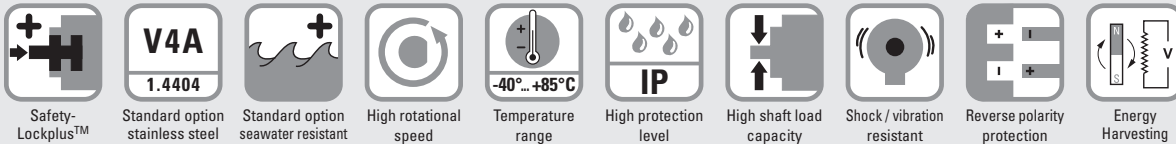

Highest robustness

- Sturdy bearing construction in Safety-Lockplus™ design for particularly high resistance.
- Extra large bearings.
- Mechanically protected shaft seal.
- Protection level IP66, IP67 and IP69k in one device.
- Wide temperature range -40°C ... +85°C.
- Without gear and without battery, thanks to the Energy Harvesting technology.

Application oriented

- Current output 4 ... 20 mA.
- Voltage output 0 ... 10 V or 0 ... 5 V.
- Measuring range scalable.
- Limit switch function.

**Order code
Shaft version**

8.M3661R.XXXX.XX12
Type a b c d e f

a Version

- 1 = standard ¹⁾
clamping flange \varnothing 42 mm [1.65"]
- 7 = stainless steel V4A ²⁾
clamping flange \varnothing 42 mm [1.65"]
all metal parts accessible from outside
are out of stainless steel V4A

b Shaft ($\varnothing \times L$), with flat

- 1 = \varnothing 6 x 12.5 mm [0.24 x 0.49"]
- 3 = \varnothing 8 x 15 mm [0.32 x 0.59"]
- 5 = \varnothing 10 x 20 mm [0.39 x 0.79"]
- 2 = \varnothing 1/4" x 12.5 mm [0.49"]
- E = \varnothing 10 x 20 mm [0.39 x 0.79"],
stainless steel V4A

c Output circuit ³⁾

- 3 = current output
- 4 = voltage output

d Type of connection

- 2 = radial cable, 1 m [3.28'] PVC
- B = radial cable, special length PVC *)
- 4 = radial M12 connector, 5-pin
- D = radial M12 connector, 5-pin ⁴⁾

*) Available special lengths (connection types B):
2, 3, 5, 8, 10, 15 m [5.56, 9.84, 16.40, 26.25, 32.80, 49.21']
order code expansion .XXXX = length in dm
ex.: 8.M3661R.133B.3112.0030 (for cable length 3 m)

e Interface / resolution / power supply

- 3 = 4 ... 20 mA / 12 bit / 10 ... 30 V DC
- 4 = 0 ... 10 V / 12 bit / 15 ... 30 V DC
- 5 = 0 ... 5 V / 11 bit / 10 ... 30 V DC

f Measuring range

- 1 = 16 revolutions / cw
- 2 = 16 revolutions / ccw
- 3 = scalable up to 65,536 revolutions,
with limit switch function / cw
- 4 = scalable up to 65,536 revolutions,
without limit switch function / cw
- 5 = scalable up to 65,536 revolutions,
with limit switch function / ccw
- 6 = scalable up to 65,536 revolutions,
without limit switch function / ccw

Optional on request

- Ex 2/22 (only for connection type 4)
- other shaft diameters out of V4A
stainless steel

1) Not in conjunction with shaft type "E".
2) Only in conjunction with shaft type "E" + type of connection "4".
3) Output circuit "3" only in conjunction with interface "3",
output circuit "4" only in conjunction with interface "4" or "5".
4) Special terminal assignment.

Absolute encoders – multiturn

Compact, robust electronic multiturn, magnetic	Sendix M3661R (shaft)	Analog
Mounting accessory for shaft encoders		Order no.
Coupling	Bellows coupling ø 19 mm [0.75"] for shaft 8 mm [0.32"]	8.0000.1102.0808 ¹⁾
Connection technology		Order no.
Cordset, pre-assembled	M12 female connector with coupling nut, 5-pin 2 m [6.56"] PVC cable	05.00.6081.2211.002M ¹⁾
Connector, self-assembly (straight)	M12 female connector with coupling nut, 5-pin	8.0000.5116.0000 ¹⁾

Further accessories can be found in the accessories section or in the accessories area of our website at: www.kuebler.com/accessories.
Additional connectors can be found in the connection technology section or in the connection technology area of our website at: www.kuebler.com/connection_technology.

Technical data

Electrical characteristics current interface 4 ... 20 mA	
Power supply	10 ... 30 V DC
Current consumption (no load)	max. 30 mA
Reverse polarity protection of the power supply	yes
Short-circuit proof outputs	yes ²⁾
Measuring range	factory setting 2 ⁴ revolutions optionally scalable up to 2 ¹⁶ revolutions
DA converter resolution	12 bit
Singleturn accuracy, at 25°C [77°F]	±1°
Temperature coefficient	< 100 ppm/K
Repeat accuracy, at 25°C [77°F]	±0.2°
Output load	at 10 V DC max. 200 Ohm at 24 V DC max. 900 Ohm at 30 V DC max. 1200 Ohm
Setting time	< 1 ms, R _{Burden} = 900 Ohm, 25°C [77°F]
LEDs (green/red)	- system status - current loop interruption – input load too high - reference point display (only with factory settings) at cw: betw. 0° and 1° at ccw: betw. 0° and -1° - status in teach mode
Options	- output signal scalable via the teach inputs - output signal scalable via the teach inputs + limit switch function
Teach inputs	level = +V for 1 s minimum
PowerON Time	< 1 s
Update rate	1 ms
e1 compliant acc. to (pending)	EU guideline 2009/19/EC (acc. to EN 55025, ISO 11452 and ISO 7637)
UL approval	File 224618
CE compliant acc. to	EMC guideline 2014/30/EU RoHS guideline 2011/65/EU

Electrical characteristics voltage interface 0 ... 10 V / 0 ... 5 V	
Power supply	output 0 ... 5 V 10 ... 30 V DC output 0 ... 10 V 15 ... 30 V DC
Current consumption (no load)	max. 30 mA
Reverse polarity protection of the power supply	yes
Short-circuit proof outputs	yes ²⁾
Measuring range	factory setting 2 ⁴ revolutions optionally scalable up to 2 ¹⁶ revolutions
DA converter resolution	0 ... 10 V 12 bit 0 ... 5 V 11 bit
Singleturn accuracy, at 25°C [77°F]	±1°
Temperature coefficient	< 100 ppm/K
Repeat accuracy, at 25°C [77°F]	±0.2°
Current output	max. 10 mA
Setting time	< 1 ms, R _{Load} = 1000 Ohm, 25°C [77°F]
LEDs (green/red)	- system status - reference point display (only with factory settings) at cw: betw. 0° and 1° at ccw: betw. 0° and -1° - status in teach mode
Options	- output signal scalable via the teach inputs - output signal scalable via the teach inputs + limit switch function
Teach inputs	level = +V for 1 s minimum
PowerON Time	< 1 s
Update rate	1 ms
e1 compliant acc. to (pending)	EU guideline 2009/19/EC (acc. to EN 55025, ISO 11452 and ISO 7637)
UL approval	File 224618
CE compliant acc. to	EMC guideline 2014/30/EU RoHS guideline 2011/65/EU

Absolute encoders
multiturn

1) Not for version "7" (V4A stainless steel)

2) When the power supply is correctly applied.

But not output to +V. Power supply and sensor output signal are not galvanically isolated.

Absolute encoders – multiturn

**Compact, robust
electronic multiturn, magnetic**

Sendix M3661R (shaft)

Analog

Mechanical characteristics

Maximum speed	4000 min ⁻¹ 2000 min ⁻¹ (continuous)
Starting torque at 20°C [68°F]	< 0.01 Nm
Shaft load capacity	radial 80 N axial 40 N
Weight	approx. 0.2 kg [7.06 oz]
Protection acc. to EN 60529/DIN 40050-9	IP66, IP67, IP69k
Working temperature range	-40°C ... +85°C [-40°F ... +185°F]

Materials

	version "1" (standard)	version "7" (stainless steel)
shaft	V2A	V4A
flange	aluminum	V4A
housing	zinc die-cast	V4A
cable	PVC	–

Shock resistance acc. to EN 60068-2-27 5000 m/s², 4 ms

Vibration resistance acc. to EN 60068-2-6 300 m/s², 10 ... 2000 Hz

Example (output signal evolution) – factory setting

Measuring range 1 (cw version)

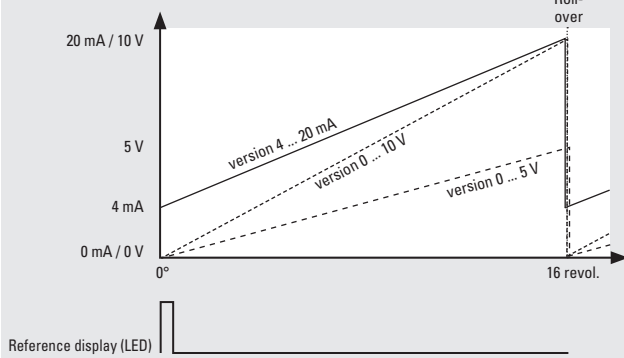

Measuring range 2 (ccw version)

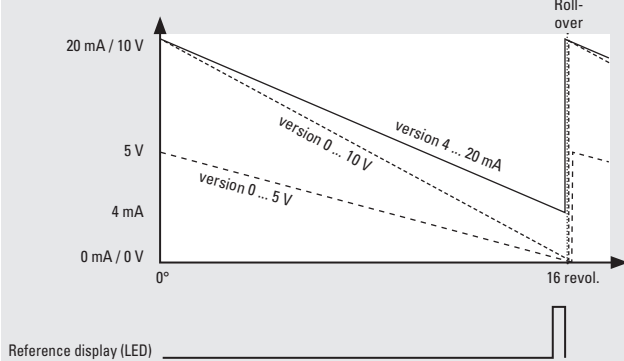

Example (output signal evolution) – option: scalable

Measuring range 4, 6 (scalable version without limit switch function)

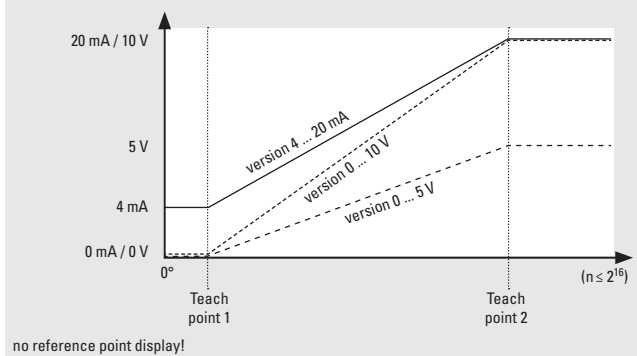

Measuring range 3, 5 (scalable version with limit switch function)

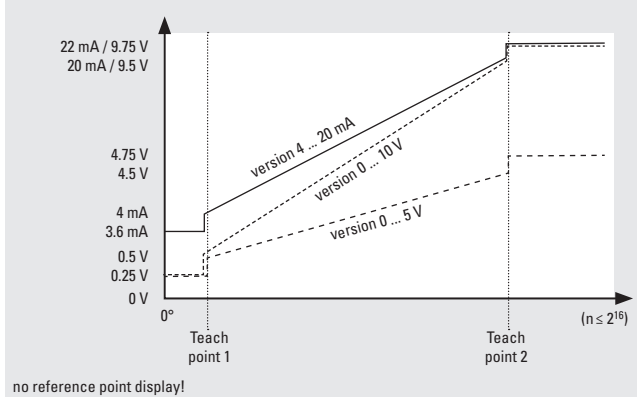

Factory-set measuring range 2⁴ revolutions with roll-over

Limit switch function	version	0 ... 10 V	0 ... 5 V	4 ... 20 mA
limit switch low		0.25 V	0.25 V	3.6 mA
limit switch high		9.75 V	4.75 V	22.0 mA

Absolute encoders – multiturn

Compact, robust electronic multiturn, magnetic	Sendix M3661R (shaft)	Analog
---	------------------------------	---------------

Terminal assignment

Interface	Type of connection	Cable (isolate unused wires individually before initial start-up)					
3 (current)	2, B	Signal:	0 V	+V	+I	SET 1 ¹⁾	SET 2 ¹⁾
		Cable color:	WH	BN	GN	GY	PK

Interface	Type of connection	M12 connector, 5 pin					
3 (current)	4	Signal:	0 V	+V	+I	SET 1 ¹⁾	SET 2 ¹⁾
		Pin:	3	2	1	5	4

Interface	Type of connection	M12 connector, 5 pin					
3 (current)	D	Signal:	0 V	+V	+I	SET 1 ¹⁾	SET 2 ¹⁾
		Pin:	3	1	2	4	5

Interface	Type of connection	Cable (isolate unused wires individually before initial start-up)					
4, 5 (voltage)	2, B	Signal:	0 V	+V	+U	SET 1 ¹⁾	SET 2 ¹⁾
		Cable color:	WH	BN	GN	GY	PK

Interface	Type of connection	M12 connector, 5 pin					
4, 5 (voltage)	4	Signal:	0 V	+V	+U	SET 1 ¹⁾	SET 2 ¹⁾
		Pin:	3	2	1	5	4

Interface	Type of connection	M12 connector, 5 pin					
4, 5 (voltage)	D	Signal:	0 V	+V	+U	SET 1 ¹⁾	SET 2 ¹⁾
		Pin:	3	1	2	4	5

+V : encoder power supply +V DC +U : voltage SET 1 : set input for teachpoint 1
 0 V : encoder power supply ground GND (0 V) +I : current SET 2 : set input for teachpoint 2

Top view of mating side, male contact base

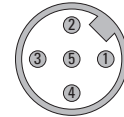

M12 connector, 5-pin

Absolute encoders
multiturn

1) For scalable version.

Absolute encoders – multiturn

Compact, robust electronic multiturn, magnetic	Sendix M3661R (shaft)	Analog
---	------------------------------	---------------

Dimensions

Dimensions in mm [inch]

**Aluminum
clamping flange, ø 42 [1.65]
version 1**

1) 3 x M3, 6 [0.24] deep

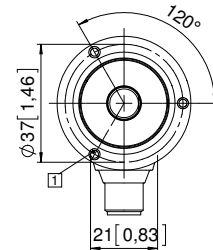
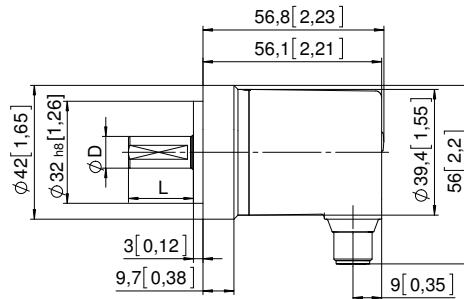

D	Fit	L
6 [0.24]	h7	12.5 [0.49]
8 [0.32]	h7	15 [0.59]
10 [0.39]	f7	20 [0.79]
1/4"	h7	12.5 [0.49]

**Stainless steel V4A
clamping flange, ø 42 [1.65]
version 7**

1) 4 x M4, 8 [0.31] deep

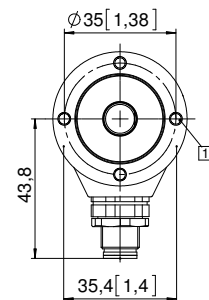
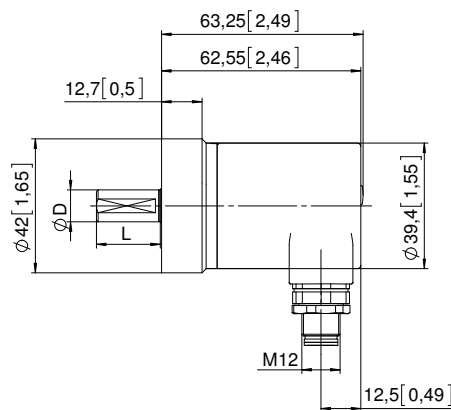

D	Fit	L
6 [0.24]	h7	12.5 [0.49]
8 [0.32]	h7	15 [0.59]
10 [0.39]	f7	20 [0.79]
1/4"	h7	12.5 [0.49]

1) For scalable version.